



ACORN

STAIRLIFTS

User Manual



Acorn Superglide 130 Straight Stairlift



ENGLISH

User Manual

3



DEUTSCH

Bedienungsanleitung

38



ESPAÑOL

Manual del Usuario

73



FRANÇAIS

Manuel d'utilisateur

108



ITALIANO

Manuale Utente

143

PCB T700

Before using your stairlift, please read through these instructions carefully.



Thank you for choosing Acorn.

You can rest assured that your stairlift will provide many years of reliable service and allow you to enjoy the full use of your home.

Your stairlift is covered by a manufacturer's warranty for 12 months that covers the cost of replacement parts.

IMPORTANT

Ensure that only an authorized and qualified Acorn trained engineer installs and services the stairlift. Under no circumstance should anyone other than an engineer trained and authorized to install, adjust, service or modify any mechanical or electrical device on this product.

Ensure the stairlift is only used in accordance with the user manual instruction. Failure to follow these warnings may result in safety system compromises which could result in serious injury or death. Acorn accepts no liability for property damage, warranty claims or personal injury, including death, in this circumstance.

After installation reliable operation and continual safe operation requires regular service and inspection. As the owner you are responsible for ensuring that regular service and inspections occur in a timely manner.

MAINTENANCE

The Stair lift owner is required to inspect the following functions every 2 months:

- General operation of the Stair lift.
- The operation of the safety sensors.
- Rail and carriage are free of debris.

Once a year, it is mandatory to call your Acorn/authorized dealer to perform the annual inspection, that includes all maintenance and safety inspections and repairs where necessary. Regular maintenance is essential for keeping your stairlift in proper operating condition.

We strongly recommend that you only use authorized engineers to perform all required maintenance, service and repair work.



USA / CANADA ONLY

Some States require that permits are obtained prior to installation, and that a licensed engineer completes the installation. Check your local regulatory requirements

Acorn, in keeping with its policy of continual development, reserves the right to change specification without prior notice. All measurements are approximate. All images are shown for illustrative purposes only. Product may vary slightly.

IMPORTANT SAFETY NOTES

PLEASE READ THE FOLLOWING BEFORE USE

ENGLISH



IMPORTANT!

To guard against injury, important safety precautions should be observed.

IMPORTANT!

Relax and sit well back in the seat with your arms on the armrests and your feet well back on the footrest.

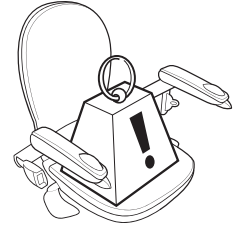

DANGER!

The stairlift is designed to carry one person at a time. Never attempt to carry more than one person.

Do NOT exceed published weight capacity. Operating any lifting device exceeding weight capacity could result in serious injury.

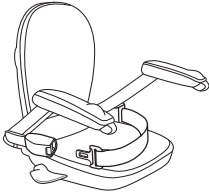

IMPORTANT!

Always wear the seatbelt, ensure it is fastened securely at all times during operation.

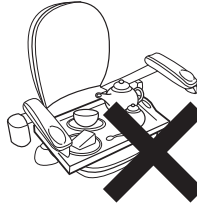

WARNING!

Do not transport food, animals, laundry or any other items. Do not use the stairlift for anything other than its intended use.

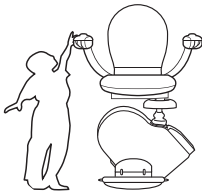

DANGER!

Do not allow children to play with the stairlift. Use by children should always be supervised.



WARNING!

Ensure other members of your household or visitors are aware that the stairlift is installed. Make them aware of any potential trip hazards (rail, hinge, footplate).

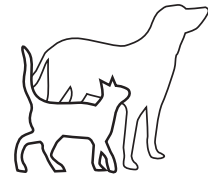

DANGER!

Ensure that household pets are out of harm's way before using the stairlift.



WARNING!

Ensure that the stairway is not being used by others and is clear of articles or obstructions before using the stairlift.

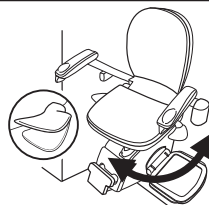

WARNING!

At the top of the stairs, always ensure the seat is rotated and locked in at a 45° or 90° angle when mounting and dismounting.



WARNING!

To avoid injury do not make contact with moving parts.

IMPORTANT SAFETY NOTES

PLEASE READ THE FOLLOWING BEFORE USE

ENGLISH

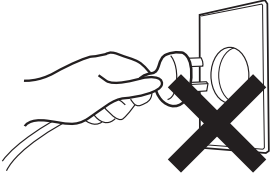

WARNING!

Do not disconnect the power supply. This will make the stairlift batteries lose their charge, and the stairlift will not operate.



WARNING!

The stairlift must not be used for firefighting or for evacuation during a fire.

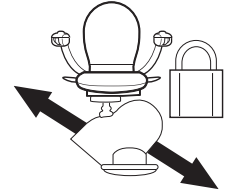

WARNING!

Ensure that the swivel seat is in the locked position before and during travel and before getting on or off the stairlift.

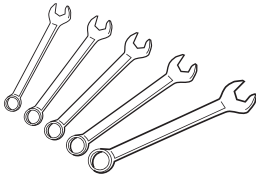

DANGER!

Always consult your Acorn representative if the need for an authorized engineer should arise.

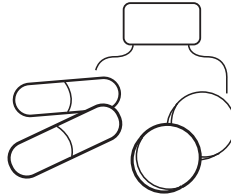

WARNING!

Do not operate the stairlift if under the influence of alcohol or drugs. If unsure, ask your physician for advice.



WARNING!

Do not use the stairlift if you have not been given a demonstration by the installation engineer.



IMPORTANT!

Please ensure that you can alert others in case you encounter difficulties when using the stairlift

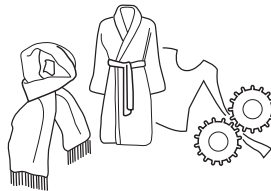

DANGER!

Ensure that there are no articles of your clothing (scarves, dressing gowns, cardigans) that could become trapped in the stairlift mechanism, as this could result in personal injury and/or damage to the equipment. Always check that your clothing is clear of the stairlift and rail before operation.



CAUTION!

It is possible for small items to be dropped onto the stairlift rail and then slide down the rail and into the stairlift mechanism. If you suspect that any foreign object has become trapped in the equipment, consult your Acorn representative before further use.

PLEASE KEEP THESE SAFETY NOTES TO HAND FOR EASE OF REFERENCE

YOUR STAIRLIFT

ENGLISH

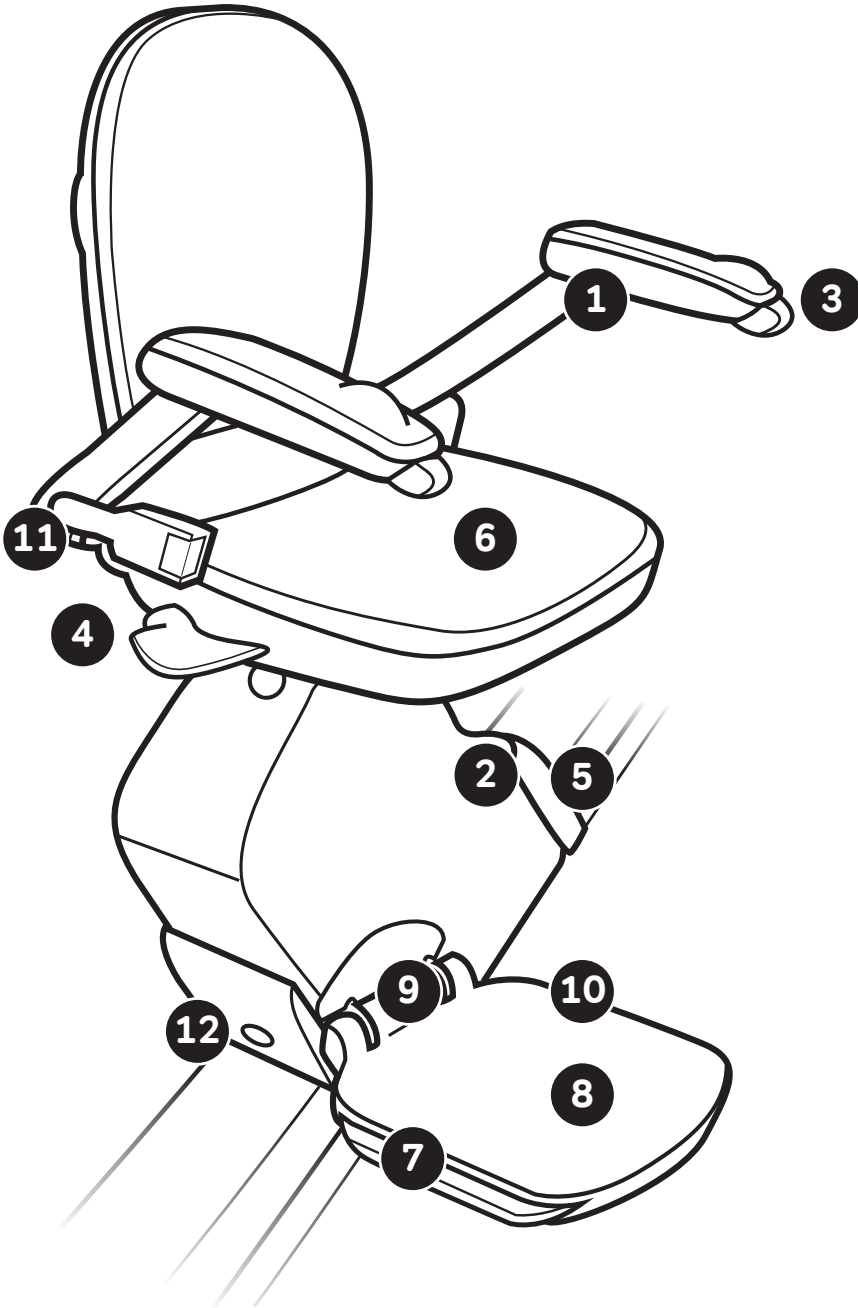

YOUR STAIRLIFT

The Acorn Stairlift is an electrically powered stairlift designed for domestic use. If used correctly, it will provide many years of safe, reliable service.

It is designed to carry one person weighing no more than 127kg (300lbs)* or 159kg (350lbs)* HD model

The Acorn Stairlift is powered by an internal battery pack that is charged from the residential mains supply/wall outlet via a transformer that reduces the voltage to a safe level. This means that there is no risk of electric shock and also that the stairlift will continue to function even if the mains electricity supply is interrupted.

- 1 Folding armrest**
- 2 Status display panel**
- 3 Paddle control**
- 4 Seat swivel lever**
- 5 Key switch**
- 6 Folding seat base**
- 7 Safety sensor down**
- 8 Footrest anti-slip surface**
- 9 Folding footrest**
- 10 Safety sensor up**
- 11 Seat belt**
- 12 Infra-red sensor**

*300lbs / 350lbs reference applies to the USA / CANADA certification ONLY.

QUICK USER GUIDE

This is a quick start reference guide to help get you started using your Acorn Superglide 130 straight stairlift.

It is important for your safety that you study this manual to completely familiarize yourself with your stairlift.



POWER OPERATION

Insert and turn key clockwise

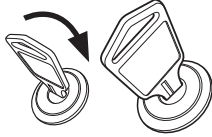

FOLDING ARMS, SEAT & FOOTREST

Fold down the arms, seat and footrest.

The downside arm of the seat must be completely down for the stairlift to operate.

The stairlift will still operate with the remote control when the arms, seat and footrest are raised.

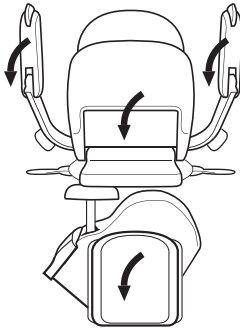

IMPORTANT - Seatbelt must be worn during operation

SEATBELT

- 1 Retract the seatbelt and pull over lap
- 2 Push seatbelt into the buckle until it clicks

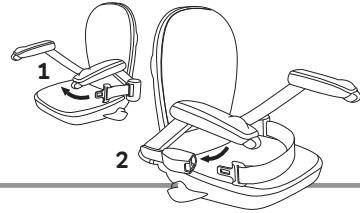

SWIVEL SEAT

At the top of the stairs push down on the lever to swivel the seat 45° and 90° to exit the lift.



The seat must be swivelled back and locked into position before operating the stairlift.

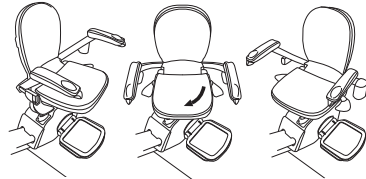

QUICK USER GUIDE



ARM CONTROL

- 1 Press the switch towards the stairs to go up
- 2 Press the switch away from the stairs to go down

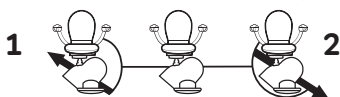
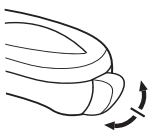

IMPORTANT - Do not disembark Until the Stairlift has reached the top or bottom of the Stairs



REMOTE CONTROL

Aim the remote at the stairlift in line with the rail.

- 1 Press the up arrow for the lift to go up.
- 2 Press the down arrow for the lift to go down.

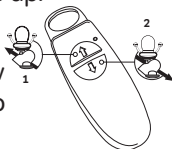

IMPORTANT - When operating the Lift for others, make sure that the user's arms are kept inside the armrests at all times and you keep a clear line of sight with the Stairlift



HINGE OPERATION

- 1 Disembark/mount the lift at the bottom of the stairs.
- 2 Using the remote control, move the lift up to an intermediate charge point if fitted, or the top charge point

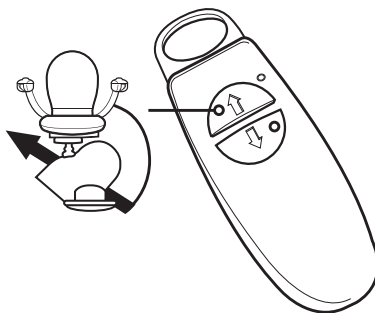

MANUAL HINGE:

Manually lift the hinge to allow access through the doorway that was obstructed.

AUTO HINGE:

The hinge will fold automatically to allow access through the doorway that was obstructed.

STAIRLIFT OPERATION

BATTERY ISOLATION SWITCH

This battery isolation switch can be found on the wall side edge / rear of the carriage cover.

Important - The switch should remain ON at all times. Failing to do so will result in the batteries losing their charge.

Please be aware this will not be covered under the warranty terms and conditions.

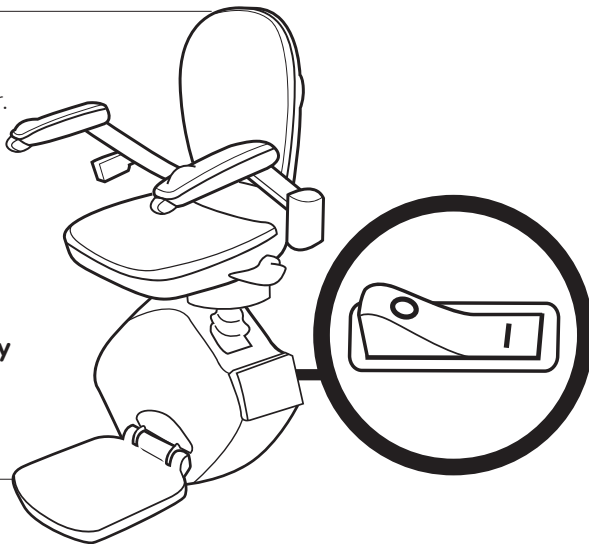

KEY SWITCH

You will find the key switch on the carriage cover.

For the unit to operate, the key must be inserted and turned to the right (clockwise).

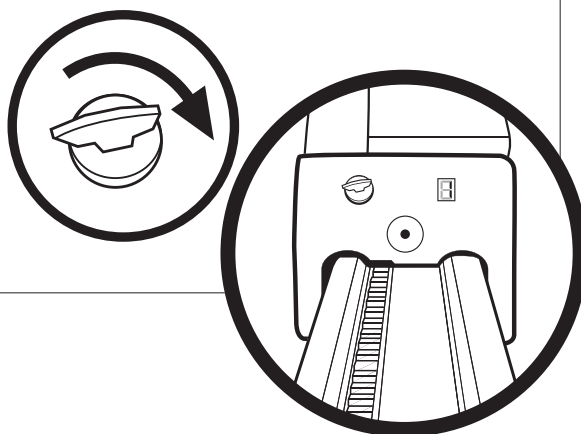

STAIRLIFT OPERATION

The display panel, positioned near the key switch, will indicate 'A1', or 'C1, C2, C3, C4, C5 or C6' if the stairlift is on a charge point.



If the display is not indicating any of these codes, please check the **DIGITAL DISPLAY CODES** on pages 24-27.

However, when the key is turned to the left or withdrawn, the display panel will show 'E9' and the stairlift will not run.



The key can also be removed to prevent any unauthorized use.

This will not affect the charging.

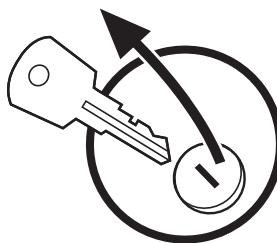

PADDLE CONTROL

The paddle control is located on the chair arms. To operate the unit, the paddle must be pressed and held in the direction of travel.

There will be an audible beep to signal that a command has been received.

The unit will only operate while the paddle is being pressed, and will automatically stop when the unit reaches the end of the track or the paddle is released.

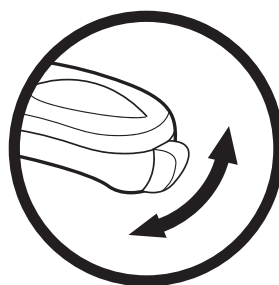

If a beep cannot be heard when the paddle is pressed, check the display code and refer to the digital display codes on pages 24-27.

STAIRLIFT OPERATION

REMOTE CONTROLS

The unit may also be operated with the remote control handset*.

There are two buttons on the handset; RED and GREEN, or UP and DOWN depending on the type of handset you have been supplied.

Point the remote control at the nearest sensor.

To send the unit UP

press and hold the RED (OR UP) button.

To send it DOWN

press and hold the GREEN (OR DOWN) button.

The unit will automatically stop at the end of the track or if the button is released.

Always point the remote control handset towards the infra-red sensor on the stairlift carriage.

NOTE: The paddle control will always override remote controls.

IMPORTANT- WHEN OPERATING THE LIFT FOR OTHERS, MAKE SURE THAT THE USER'S ARMS ARE KEPT INSIDE THE ARMRESTS AT ALL TIMES AND YOU KEEP A CLEAR LINE OF SIGHT WITH THE STAIRLIFT

The infrared sensors for the remote controls are located on the carriage.

The remote control needs to point at these to work efficiently to operate the stairlift.

The top sensor is located near the digital display.

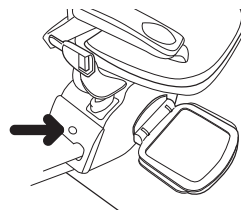

The bottom sensor is located on the bottom plate near the rail.

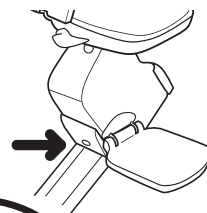

Occasional interference from outside sources may, in some instances, cause the lift to stop. This is a normal feature, designed to prevent accidental operation. The remote control will require the button to be released and pressed again.

IT IS RECOMMENDED THAT THE BATTERY IN THE REMOTE CONTROL HANDSET IS REPLACED ANNUALLY

*Remote handset may vary from that shown

STAIRLIFT OPERATION

HOW TO CHANGE THE REMOTE BATTERY

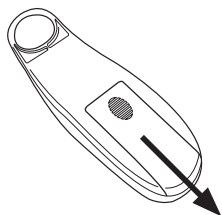

Slide the battery cover off the reverse of the remote control.

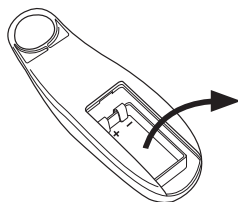

Remove the battery. Please take old batteries to a recycling centre or a collection point at your local electrical store or supermarket.

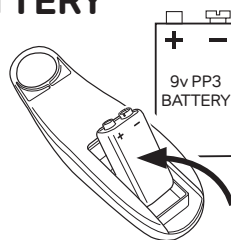

Insert the new battery base first and push down firmly. Slide the cover on.

Please ensure that the battery is connected correctly. If the battery is connected wrong it could damage the remote and may require replacing.

The unit will operate with the seat pad or footrest in the folded position. However, it will not work if the seat has been turned to the 45° and 90° position, or the safety arm has been left up*. This will be indicated by 'E6' on the display panel.



The downside arm of the seat must be completely down for the stairlift to operate.

*Perch/Sit-Stand Models

MANUAL SWIVEL SEAT

When the unit reaches the upper end of the track, it will stop automatically. The seat must now be turned to make getting on and off the stairlift safe.

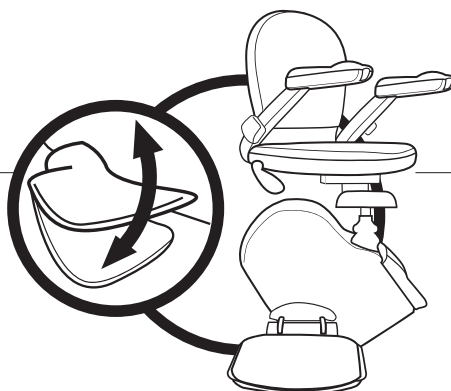

STAIRLIFT OPERATION

To turn the seat, depress and hold down the seat swivel lever at the side of the seat pad. This will then allow the seat to be rotated to face the staircase landing. The seat will lock in position at 45° and 90°.

Make sure the seat is locked into position before getting on or off the stairlift.

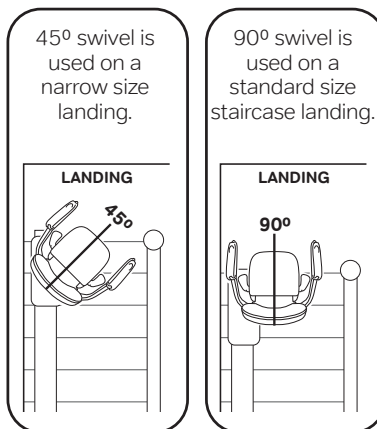

The unit should not be operated until the seat has been rotated back and locked to the travel position. Failure to do so will indicate 'E6' on the display panel. The unit will also fail to operate if the down arm is in the folded position.



Safety Note: The footrest does not swivel, and the seat only swivels at the top of the staircase.

POWERED SWIVEL SEAT

PADDLE CONTROL OPERATION

When the unit reaches the upper end of the track, it will stop automatically.

After a short delay, the seat will start swiveling and stop once the 90° position has been reached.

It is important that the seatbelt is undone ONLY when the seat has fully swivelled and it is safe to leave the stairlift.

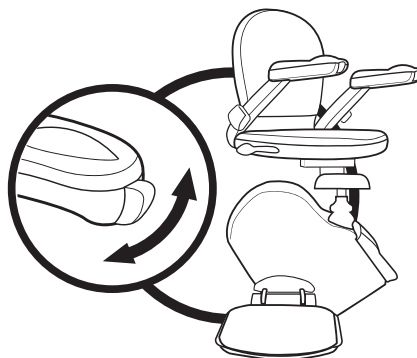

STAIRLIFT OPERATION

REMOTE CONTROL OPERATION

Using the remote control handset, release and press again to start the seat swivel operation.

The unit should not be operated until the seat has been rotated back to the travel position. Failure to do so will indicate 'E6' on the display panel.

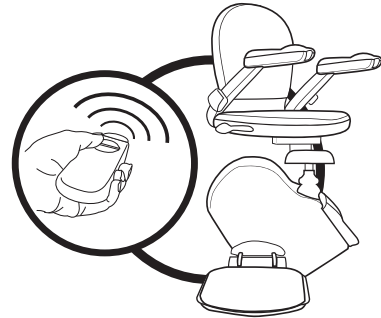

The unit will also fail to operate if the down arm is in the folded position.



SAFETY NOTE: The footrest does not swivel, and the seat only swivels at the top of the staircase.

POWERED FOOTREST

If a Powered Footrest is fitted, at the top or bottom of the stairs, after the stairlift comes to a stop, undo the seat belt and leave the stairlift.

Using the buttons located along both sides of the seat, lower or raise the footrest as required.

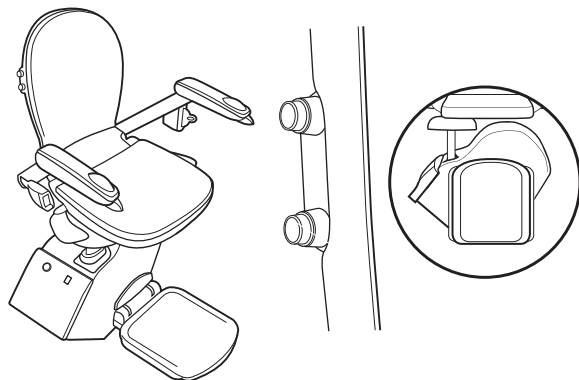

STAIRLIFT OPERATION

HINGE SECTION

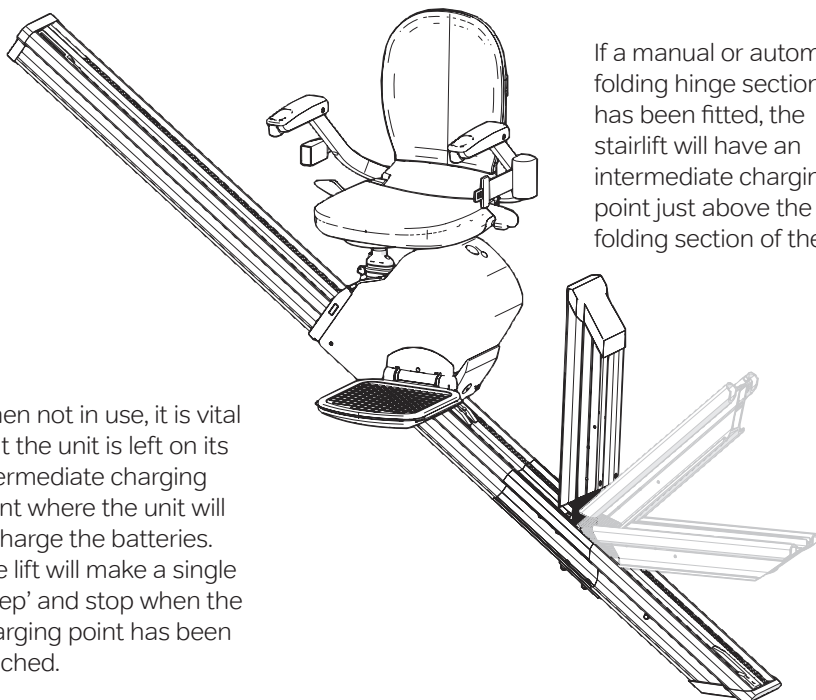

If a manual or automatic folding hinge section has been fitted, the stairlift will have an intermediate charging point just above the folding section of the rail.

When not in use, it is vital that the unit is left on its intermediate charging point where the unit will recharge the batteries. The lift will make a single 'beep' and stop when the charging point has been reached.

MANUAL HINGE INSTALLATION

Disembark the lift at the bottom of the stairs. To park the lift, press the UP direction on the remote controls until the lift beeps and stops on the intermediate charging point. You can now fold the hinge section by hand.

To call the lift, unfold the hinge section by hand. Using the remote control, call the lift down to its lower stopping position. You can now mount the lift at the bottom of the stairs.

AUTO HINGE INSTALLATION

Disembark the lift at the bottom of the stairs. To park the lift, press the UP direction on the remote controls until the lift beeps and stops on the intermediate charging point. The hinge will fold up automatically.

Using the remote control, call the lift down to its lower stopping position. The folding hinge will lower automatically. You can now mount the lift at the bottom of the stairs.

STAIRLIFT OPERATION

SEAT BELT

To fasten the seat belt, pull out the belt and insert the clasp into the buckle.

A positive click should be heard, indicating that the lock has engaged properly.

To release the seat belt, hold the belt with one hand and press the release button on the buckle.

The clasp will automatically release and allow the belt to retract.

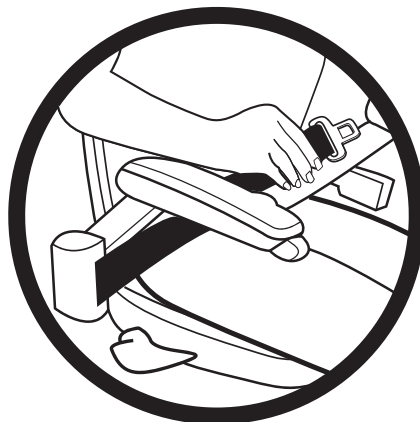

SEAT BELT MUST BE WORN AT ALL TIMES WHEN USING THE STAIRLIFT
It is important that the belt is held while it retracts, otherwise it will retract too fast, resulting in the belt 'whipping' which may cause injury.

FOLDING SEAT/FOOTREST

The seat, arms and footrest can be folded up when not in use to allow greater access on the stairway, efficiently using the space in your hallway. The lift can still be operated using the remote control handset.

Note: The stairlift will not run if the downside arm is folded upwards. The downside arm must be completely down for the stairlift to operate. The stairlift can still be called with the remote controls.

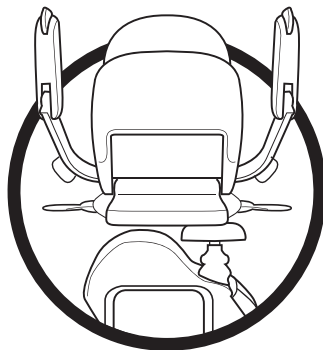

STAIRLIFT OPERATION

PARKING AND RECHARGING

When not in use, it is vital that the unit is left on a charge point. The location of this will depend upon which type of track is fitted.

On a standard track, the correct positions are at the top or bottom where the unit stops automatically. At these positions, the unit receives a power supply from the mains/transformer that allows the unit to recharge its internal batteries. The lift will make a single 'beep' to indicate that a charge point has been reached.

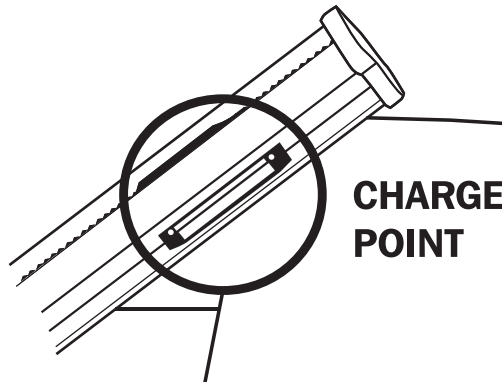

Note: If there is a mains electrical supply failure, or if the supply to your stairlift is switched off, it will continue to work for several journeys. However, the batteries will eventually lose their charge and the stairlift will not operate.



A DEDICATED POWER SOCKET MUST BE AVAILABLE FOR THE STAIRLIFT. The mains electricity supply/transformer should be left permanently connected and switched on.

It is imperative to ensure there is a continual supply of power to the stairlift. The stairlift batteries can cover short term interruptions to the power supply, but without a supply of power, will eventually become too low to be recharged.

If this happens, the batteries will have to be replaced by an engineer, which is not covered by the manufacturer's warranty and is a chargeable service.

SAFETY FEATURES

The stairlift comes with an array of safety features as standard; including:

- **Carriage safety pads; upper and lower**
Stops stairlift upon contacting an obstruction on the rail
- **Footrest safety edges; upper and lower**
Stops stairlift upon contacting an obstruction on stairway
- **Swivel seat switch**
Prevents the movement of the stairlift when the seat has been swivelled to 45° and 90°
- **Final limit switch**
Prevents the stairlift from travelling too far along the rail
- **Over speed governor and safety gear**
Prevents uncontrolled descent
- **No-charge warning**
Audible warning sound - alerts when the stairlift is not charging
- **Retractable Seat Belt**
Must be worn at all times during operation
- **Downside Arm Interlock**
The stairlift seat arms must be in the down position for the stairlift to operate

If one or more of the safety devices are activated, an appropriate code will be indicated on the display panel. These codes can be found in the **DIGITAL DISPLAY CODES** on pages 24-27 together with the appropriate action required.

OVER SPEED GOVERNOR

The lift is fitted with a safety device (OSG) that will lock the lift to the rail in the event of a mechanical failure or excessive speed. If the OSG operates spuriously due to excessive shock or vibration, indicated by 'F7' on the display panel, it is possible to reset it (see page 20).



SAFETY FEATURES

HAND WINDING

In an emergency, the stairlift may be hand wound to clear any obstruction.



If this symbol is displayed, DO NOT hand-wind the stairlift in the down direction because this could damage it. Always observe for possible obstructions.



1. Turn off the battery isolation switch.
2. Remove the blanking cover and insert the hand winder onto the motor spindle. Follow the instructions on the label inside the top of the hand winder.

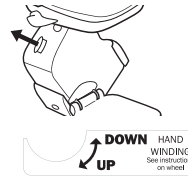
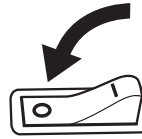

If this symbol is displayed, follow the instructions below.

1. Turn the hand winder in a clockwise direction so the lift moves up the track approximately one inch (2.5cm).
2. Remove the hand winder and turn on the battery isolation switch.
3. Check the digital display panel has changed from 'F7' to 'A1'. If it still displays 'F7' repeat the above steps.
4. Once 'A1' is displayed, run the lift up until it stops automatically, and then down to check all operations are running as they should. Replace the blanking cover.

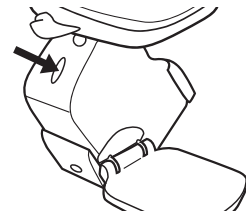
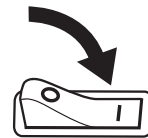
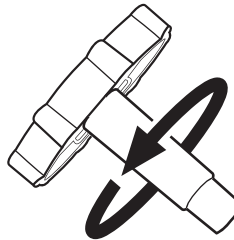

CAUTION! Never run the stairlift with the winding wheel in place as it could result in serious injury or damage. Never wind the stairlift counter-clockwise/anti-clockwise if the fault code 'F7' shows, as this will result in damage to the OSG.

IF IN DOUBT, CONTACT YOUR AUTHORIZED ACORN REPRESENTATIVE FOR FURTHER ADVICE

CARE AND MAINTENANCE

REMOTE CONTROLS

As previously described on page 12, there may be occasions when the remote control handsets* will lose programming due to outside interference. If this happens, you can reset the remote control by parking the lift on its charge point.. Then remove the key from its location so that the digital display is showing 'E9'.

Press the lower safety edge on the carriage and, at the same time, press the **DOWN** button on the remote control.

When the key is inserted back into its location and turn right (clock wise), the remote control handset will be correctly programmed.

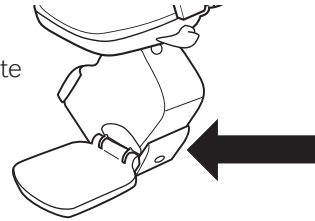

The remote controls work by using an infrared light source. This naturally occurring light source can also be emitted by certain types of low energy bulbs. If it is found that such a bulb is causing interference with the remote controls, it is recommended that it be changed to a standard one.

IT IS RECOMMENDED THAT THE REMOTE CONTROL BATTERIES ARE REPLACED ANNUALLY.

*Remote handset may vary from that shown

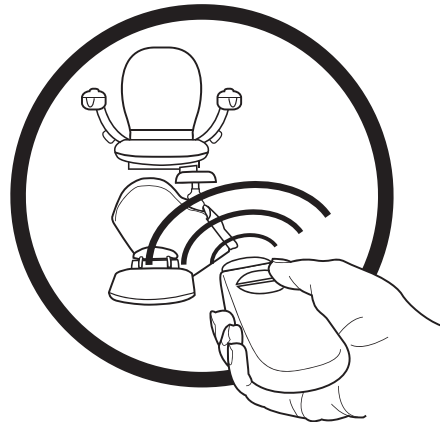

IMPORTANT- WHEN OPERATING THE LIFT FOR OTHERS, MAKE SURE THAT THE USER'S ARMS ARE KEPT INSIDE THE ARMRESTS AT ALL TIMES AND YOU KEEP A CLEAR LINE OF SIGHT WITH THE STAIRLIFT

RAILS

It is recommended that the rail should be cleaned on a weekly basis. This should be done with a dry cloth, and you can use simple household polish. **Under no circumstances should you use a damp cloth with abrasive cleaner.** Failure to clean the track on a regular basis will lead to a build up of dust on the internal rollers of the stairlift, which will in turn leave black marks; and in some instances will leave a residue which can look similar to metal shavings.

It is also recommended that the steel-toothed rack, mounted on the rail itself, should be vacuumed out on a regular basis.

CARE AND MAINTENANCE

SAFETY EDGES

Should the stairlift become unoperational (displaying 'E1', 'E2', 'E4', 'E5') this could be due to one of the safety edges being trapped. This can be overcome by moving the stairlift back in the opposite direction and removing the obstruction or simply tapping the relevant safety edge gently.

If this doesn't rectify the problem, contact your authorized Acorn representative for further assistance.

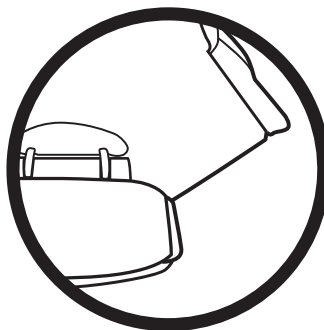

SLEEP MODE

If the stairlift is not parked on a charge point, or in the event of a power failure, the stairlift will 'beep' continuously for approximately 60 seconds, after which the stairlift will enter SLEEP MODE. Once in sleeping mode, the stairlift will 'beep' twice approximately every 40 seconds. The user can 'wake' the stairlift at any time by using the paddle controls or remote control handset. Once woken, park the stairlift on a charge point as normal.

RESET

On certain occasions, it may be necessary to reset the control board of the stairlift. Switch the Battery Isolation Switch OFF (see page 10), leave for 30 seconds, then switch back on. This will reset the fault codes on the display panel.

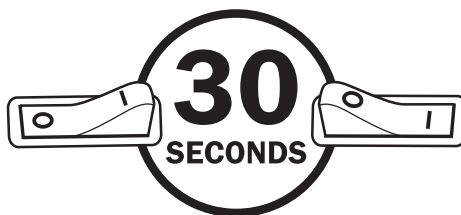

SERVICING

It is recommended that your stairlift is serviced every 12 months by your stairlift supplier to ensure it remains safe and reliable. Your stairlift is designed to operate smoothly and quietly. The equivalent continuous A-Weighted sound pressure level of this equipment does not exceed 70db (A). For safety reasons, only Acorn specified parts should be used. Use of parts that are not Acorn approved could affect the safety of your stairlift.

CARE AND MAINTENANCE

FCC

The equipment has been tested and complies fully with Class A of 47CFR 2011 part 15 certification. If not installed correctly by an Acorn Qualified Technician there may be some interference with other household equipment (i.e TV and Radio reception).

This can be rectified by moving this equipment to a different location.

OUTDOOR MODELS

The outdoor model operates in exactly the same way as the indoor model, but is fully compliant with all national standards with regard to outdoor weathering. Proper care and maintenance is required as normal; i.e. regular servicing and regular external cleaning.

The rainproof / dustproof cover supplied with the stairlift should be used when the stairlift is not in use. The cover is used to keep off leaves and garden debris as well as providing additional protection for your stairlift from the elements.

Acorn cannot accept any claims for damages under warranty if the required care and attention recommendations are not followed.

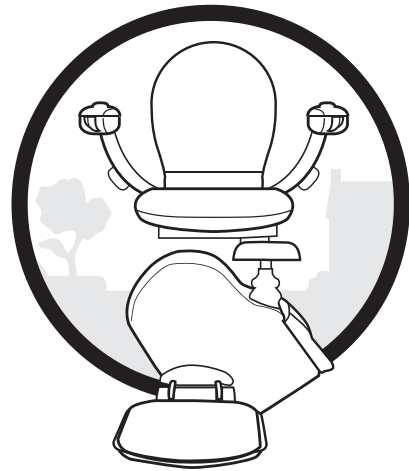

HD MODEL

The HD model operates in exactly the same way as the standard model. Proper care and maintenance is required as normal; i.e. regular servicing and regular external cleaning. Certified to 159kg (350lbs)*.





Acorn cannot accept any claims for damages under warranty if the required care and attention recommendations are not followed.

*300lbs / 350lbs reference applies to the USA / CANADA certification ONLY.

DIGITAL DISPLAY CODES



CHARGING CODES LIFT WILL OPERATE AS NORMAL

1



	NORMAL - Battery is charging Charger connected and operating properly. C1 being battery low in charge, progressively increasing to C5 sustained charged.	<ul style="list-style-type: none">• Lift is operating normally
	NORMAL - Battery is fully charged Charger connected but not charging - battery is at maximum charge capacity	<ul style="list-style-type: none">• Lift is operating normally
	FAULT - Charge voltage too low Charger connected but not operating as required	<ul style="list-style-type: none">• Contact your authorized Acorn dealer for assistance
	FAULT - Charge voltage too high Charger connected but not operating as required	<ul style="list-style-type: none">• Contact your authorized Acorn dealer for assistance
	FAULT - Battery fault Charger connected but not charging - battery is not found, or is faulty	<ul style="list-style-type: none">• Contact your authorized Acorn dealer for assistance

STANDARD OPERATING CODES LIFT WILL OPERATE AS NORMAL

2

	NORMAL - Power down / Sleep mode No display shown. Lift is either receiving no power; or is in sleep mode.	<ul style="list-style-type: none">• Check that the Battery Isolation switch is in the ON position• Activate the directional paddle to wake the stairlift from 'SLEEP' mode
	NORMAL - No charge LIFT WILL BEEP Lift has been parked off a charge point, and is receiving no charge.	<ul style="list-style-type: none">• Activate the directional paddle and drive the stairlift to a charge point• Check that the mains supply has not been turned off



DIGITAL DISPLAY CODES

	<p>NORMAL - Lift moving up Lift is in operation, and moving upward. Armrest toggle has been activated.</p>	<ul style="list-style-type: none"> • Lift is operating normally
	<p>NORMAL - Lift moving down Lift is in operation, and moving downward. Armrest toggle has been activated.</p>	<ul style="list-style-type: none"> • Lift is operating normally

2

STANDARD OPERATING CODES





LIFT WILL OPERATE AS NORMAL

	<p>NORMAL - Lift moving up (remote) Lift is in operation, and moving upward. Remote control has been activated.</p>	<ul style="list-style-type: none"> • Lift is operating normally
	<p>NORMAL - Lift moving down (remote) Lift is in operation, and moving downward. Remote control has been activated.</p>	<ul style="list-style-type: none"> • Lift is operating normally
	<p>NORMAL - Lift operating the hinge section Complete operation until the hinge is in line with the rail or fully folded.</p>	<ul style="list-style-type: none"> • Lift is operating normally



3

OPERATING ERROR CODES





LIFT WILL NOT OPERATE

	<p>NORMAL - Safety edge activated Footrest DOWN safety edge or underplate has been activated</p>	<ul style="list-style-type: none"> • Check the footrest DOWN safety edge for obstruction
	<p>NORMAL - Safety edge activated Footrest UP safety edge has been activated</p>	<ul style="list-style-type: none"> • Check the footrest UP safety edge for obstruction
	<p>NORMAL - Safety edge activated Carriage DOWN safety edge has been activated</p>	<ul style="list-style-type: none"> • Check the carriage DOWN safety edge for obstruction
	<p>NORMAL - Safety edge activated Carriage UP safety edge has been activated</p>	<ul style="list-style-type: none"> • Check the carriage UP safety edge for obstruction
	<p>NORMAL - Seat not in place The stairlift seat is not in the riding position</p>	<ul style="list-style-type: none"> • Turn the seat back to the riding position



DIGITAL DISPLAY CODES

	<p>NORMAL - Battery low Bring the unit down to the nearest charging station. The unit won't allow the user to travel in the UP direction until the batteries are sufficiently charged and the code has cleared.</p>	<ul style="list-style-type: none"> • Activate the directional toggle switch and drive the stairlift to a charge point
	<p>NORMAL - Key switch off Key switch is in the OFF position</p>	<ul style="list-style-type: none"> • Check that the key is in and turned to the ON position

HARDWARE FAULT CODES 4 LIFT WILL NOT OPERATE

	<p>NORMAL - Safety grounded to chassis (SW1 safety circuit)</p>	<ul style="list-style-type: none"> • Check continuity between every switch in the SW1 or SW2 safety circuit and chassis
	<p>NORMAL - Safety grounded to chassis (SW2 safety circuit)</p>	
	<p>FAULT - Hinge communication fault The stairlifts is failing to operate the hinge section.</p>	<ul style="list-style-type: none"> • Check that the mains supply has not been turned off or unplugged from the wall. • Contact your authorized Acorn dealer for assistance
	<p>FAULT - Hinge end position not reached The hinge section cannot get in line with the rail or fully folded.</p>	<ul style="list-style-type: none"> • Check for obstructions around the hinge section. • Contact your authorized Acorn dealer for assistance

FATAL ERROR CODES 5 LIFT WILL NOT OPERATE

	<p>FAULT - Relay fault</p>	<ul style="list-style-type: none"> • Reset the stairlift (power off for 30 seconds) • If not resolved, contact your authorized Acorn dealer for assistance
	<p>FAULT - Brake fault</p>	<ul style="list-style-type: none"> • Reset the stairlift (power off for 30 seconds) • Drive the stairlift to a charge point, and leave to charge for one hour • If not resolved, contact your authorized Acorn dealer for assistance







FATAL ERROR CODES continued on next page

DIGITAL DISPLAY CODES

5

FATAL ERROR CODES LIFT WILL NOT OPERATE

ENGLISH

	<p>FAULT - Motor overcurrent fault</p>	<ul style="list-style-type: none"> • Reset the stairlift (power off for 30 seconds) • If not resolved, contact your authorized Acorn dealer for assistance
	<p>FAULT - Battery flat - Audible alarm The battery level is really low</p>	<ul style="list-style-type: none"> • Press the arm switch control or the remote control once to stop the alarm. • With E7 on display, bring the unit down to the nearest charging station and recharge the batteries.
	<p>FAULT - Final limit overrun</p>	<ul style="list-style-type: none"> • Hand wind the stairlift up OR down (see page 20) • If not resolved, contact your authorized Acorn dealer for assistance
	<p>FAULT - OSG switch</p>	<ul style="list-style-type: none"> • Hand wind the lift UP to reset the OSG (see page 20)
	<p>FAULT - Safety edge activated</p>	<ul style="list-style-type: none"> • Carriage/footplate DOWN safety edge has been activated whilst the lift is at the highest stopping position • Check the DOWN carriage /footplate safety edge for obstruction
	<p>FAULT - Safety edge activated</p>	<ul style="list-style-type: none"> • Carriage/footplate UP safety edge has been activated whilst at the lowest stopping position • Check the UP carriage /footplate safety edge for obstruction

OPERATIONAL PROBLEMS

LIFT OPERATION INTERRUPTED DURING USE

ENGLISH



IMPORTANT!

OBSERVE THE FOLLOWING POINTS BEFORE USING THE STAIRLIFT

- Please ensure that you can alert others in case you encounter difficulties when using the stairlift



- Ensure that the stairway is not being used by others and is clear of articles or obstructions

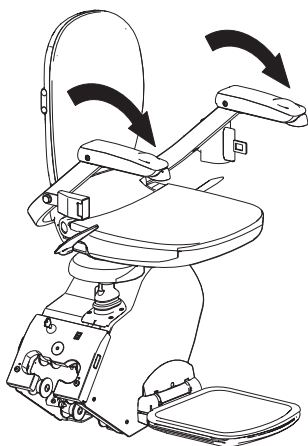

- Remain calm on the stairlift, ensuring that both arms are in the down position.
- Release the direction controller on the arm rest and press again in the OPPOSITE direction.

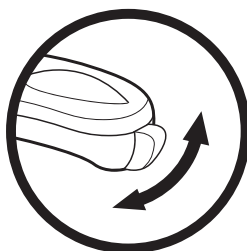

In the unlikely event that you need to disembark the stairlift mid travel, always attempt to swivel the seat towards the stairs.

OPERATIONAL PROBLEMS

DISEMBARKING THE STAIRLIFT IN CASE OF EMERGENCY



IMPORTANT!

In the unlikely event that you need to disembark the stairlift mid travel, always attempt to swivel the seat towards the stairs.

Turn the seat, depressing and holding the seat swivel lever at the side of the seat pad. (Powered swivel units can be rotated manually without the need of depressing the seat pads).

This will then allow the seat to be rotated to face the staircase.

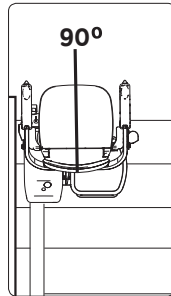
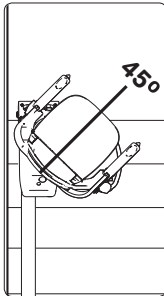
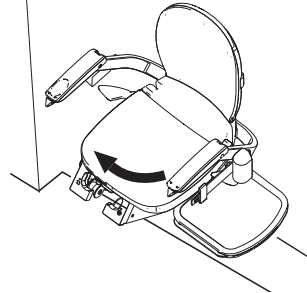
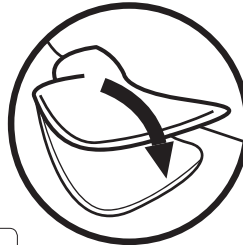

The seat will lock at a 45° or 90° angle.



IMPORTANT!

MAKE SURE THE SEAT IS LOCKED INTO POSITION BEFORE ATTEMPTING TO DISEMBARK THE STAIRLIFT.



IMPORTANT!

IT IS IMPORTANT THAT THE SEAT BELT IS UNDONE ONLY WHEN THE SEAT HAS BEEN FULLY SWIVELLED TO FACE THE STAIRCASE AND LOCKED INTO POSITION.

LABELS

ENGLISH

A

Europe / Rest of world

ACORN SUPERGLIDE 130 T700
MANUFACTURED BY ACORN STAIRLIFTS

INSTALLER:

POWER SUPPLY (PSU) INPUT 100-240 VAC, 50-60 Hz
"CLASS 2" OUTPUT 28 VDC, 1.2 A

BATTERIES 24 VDC (2 X 12 VDC, 7 AH)

DRIVE RACK AND PINION

MAX SPEED 27 fpm (0.15m/sec)

SERIAL # D.O.M.

WARNING
RATED LOAD "ONE PERSON ONLY" AT MAX. WEIGHT 127 Kg

CE
STAIRLIFT

US / Canada

ACORN SUPERGLIDE 130 T700
MANUFACTURED BY ACORN STAIRLIFTS

INSTALLER:

POWER SUPPLY (PSU) INPUT 100-240 VAC, 50-60 Hz
"CLASS 2" OUTPUT 28 VDC, 1.2 A

BATTERIES 24 VDC (2 X 12 VDC, 7 AH)

DRIVE RACK AND PINION

MAX SPEED 27 fpm (0.15m/sec)

SERIAL # D.O.M.

WARNING
RATED LOAD "ONE PERSON ONLY" AT MAX. WEIGHT 300 lbs (127 kg)

TESTED TO: ASME A 18.1 - 2017, ASME A 17.5 - 2014
Controller for elevating devices for people with physical disabilities
Contrôleur d'équipement ascenseur pour personnes handicapées
Certified for Electrical safety only
Certifié de point de vue sécurité électrique seulement

CSA B44.1
ASME A 17.5

FC
Acorn Stairlifts
Acorn 130
FC020400-000000

C (UL) LISTED
STAIRLIFT CHAIRLIFT

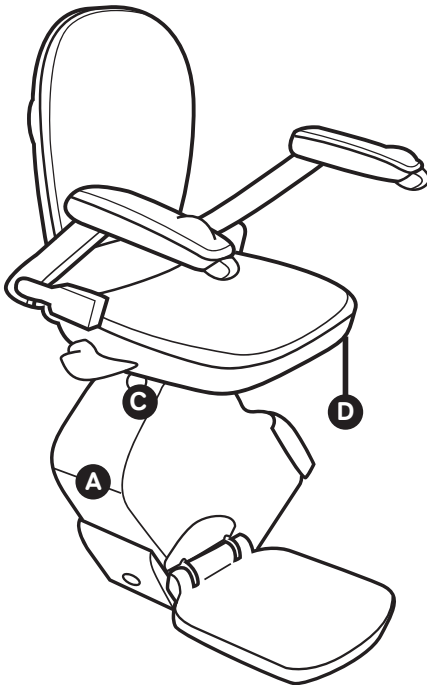
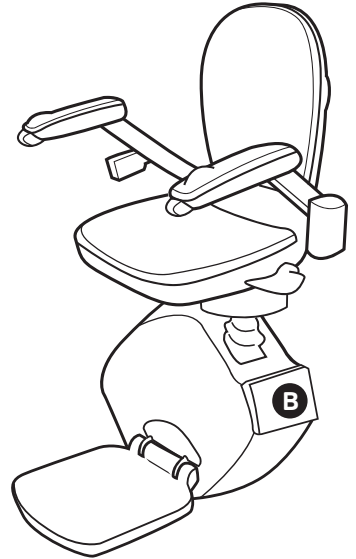

HAND WINDING WHEEL

DO NOT USE UNLESS DIRECTED BY SERVICE ENGINEER!

INSTRUCTIONS

1. Turn off battery isolation switch
2. Remove cover from access hole
3. Insert this hand winding wheel
4. Wind in desired direction keeping Stairlift under constant surveillance
5. Turn on battery isolation switch and replace cover

WARNING! The lift will not work if wound beyond its normal stopping position.

D

Address Label (under seat)

Manufactured By Acorn Stairlifts
Telecom House
Millennium Business Park
Station Road, Steeton
England BD20 6RB

C

DOWN

UP

HAND WINDING
See instructions on wheel

WIRING DIAGRAMS

LOW VOLTAGE WIRING CONTROL BOARD T700

CONN 1

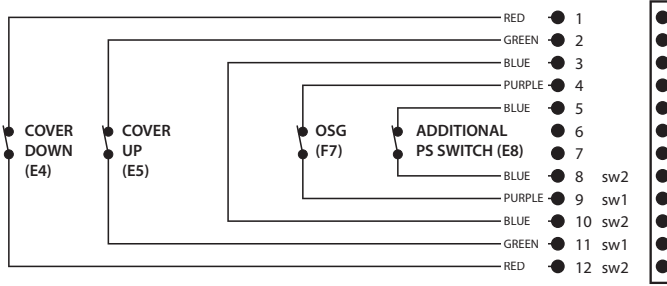

CONN 2

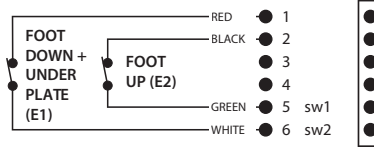

CONN 3

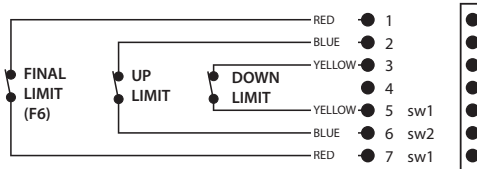

CONN 4

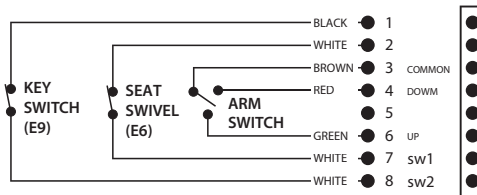

WIRING DIAGRAMS

LOW VOLTAGE WIRING CONTROL BOARD T700

ENGLISH

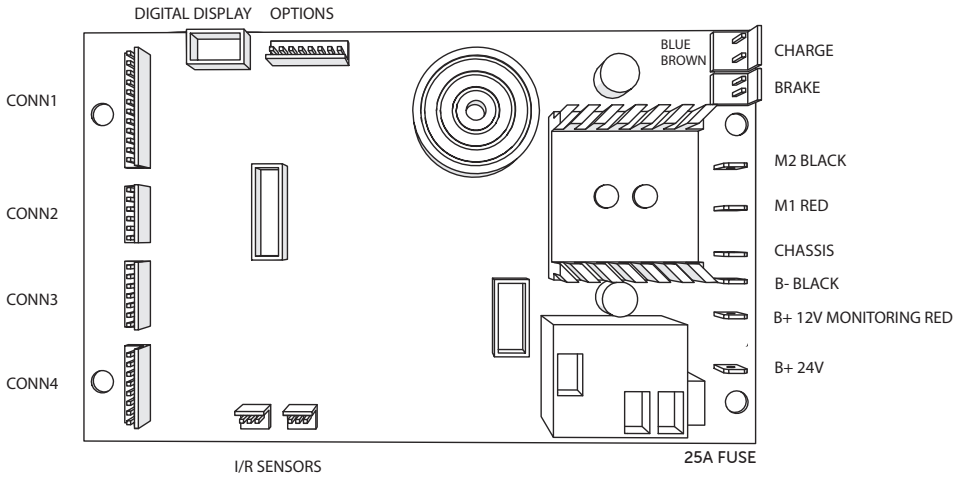



EC Declaration of Conformity

Manufacturer: Acorn Mobility Services Ltd.
Telecom House
Millennium Business Park
Station Road, Steeton
West Yorkshire, England
BD20 6RB

Lothian Electric Machines Ltd.
Hospital Road
Haddington
East Lothian
Scotland
EH41 3PD

T: +44 (0) 1535 695 448
F: +44 (0) 1535 290 006
www.acornstairlifts.com

T: +44 (0) 1620 828 700
F: +44 (0) 1620 828 730
www.lemac.com

Product: Stairlift
Model: Acorn 130 T700
Straight Stairlift

Serial No:

Acorn Mobility Services declares that the above referenced product is in conformity with the essential requirements of:

Machinery Directive 2006/42/EC; Electromagnetic compatibility directive 2014/30/EU; Low voltage directive 2014/35/EU.

Radio equipment directive 2014/53/EU, ETSI EN 300-220-2 V3.1.1
We manufacture our products to the following standards:

- EMC: EN55014-2:2015; EN55014-1:2016 +A1:2009, A2:2011; EN61000-3-2:2014; EN61000-3-3:2013; EN301 489.1 V2.1.1; EN301 489-3 V2.1.1; EN55032:2015
- Radio: ETSI EN 300-220-2 V3.1.1
- FCC: 47CFR15; ANSI C63-10:2013 (USA) RSS210 Issue 9 Clause A1.2 (Canada)
- LVD: 2014/35/EU; EN ISO 14120:2015; EN61558-2-6:2009; EN61558-1:2005 +A1:2009; EN12015:2014
- Other Standards: BS EN ISO 9386-2:2000; BS EN 81-40:2020; EN60204-1:2006
CAN/CSA B355:2015; CSA B44.1/ASME A 17.5:2014; ASME A 18.1:2017

The Technical Construction File, as required by Directive 2006/42/EC is maintained at the corporate headquarters of Acorn Mobility Services Ltd, Telecom House, Millennium Business Park, Station Road, Steeton, England. BD20 6RB.

Date: **December 2020**

Simon Broder
Technical Manager



Acorn promotes responsible recycling. Do not attempt to dispose of the stairlift yourself



SERVICE RECORD

Service Date:

Next Service Due:

Engineer Signature:

Customer Signature:

Service Date:

Next Service Due:

Engineer Signature:

Customer Signature:

Service Date:

Next Service Due:

Engineer Signature:

Customer Signature:

Service Date:

Next Service Due:

Engineer Signature:

Customer Signature:

Service Date:

Next Service Due:

Engineer Signature:

Customer Signature:

SERVICE RECORD

Service Date:

Next Service Due:

Engineer Signature:

Customer Signature:

Service Date:

Next Service Due:

Engineer Signature:

Customer Signature:

Service Date:

Next Service Due:

Engineer Signature:

Customer Signature:

Service Date:

Next Service Due:

Engineer Signature:

Customer Signature:

Service Date:

Next Service Due:

Engineer Signature:

Customer Signature:

SERVICE RECORD

Service Date:

Next Service Due:

Engineer Signature:

Customer Signature:

Service Date:

Next Service Due:

Engineer Signature:

Customer Signature:

Service Date:

Next Service Due:

Engineer Signature:

Customer Signature:

Service Date:

Next Service Due:

Engineer Signature:

Customer Signature:

Service Date:

Next Service Due:

Engineer Signature:

Customer Signature:



ACORN

STAIRLIFTS

www.acornstairlifts.com



Acorn reserves the right to change specification without prior notice. All measurements are approximate. Images are shown for illustrative purposes only. Product may vary slightly.

All information correct at time of going to print. E&OE.

COPYRIGHT ©2017 ACORN MOBILITY SERVICES LIMITED All Rights Reserved

42112-133 / AC7273 / 1220